

caFINA® XT6



## Melitta® Cafina® XT6

Coffee perfection in every cup.  
Made in Switzerland.

Melitta Professional  
Coffee Solutions



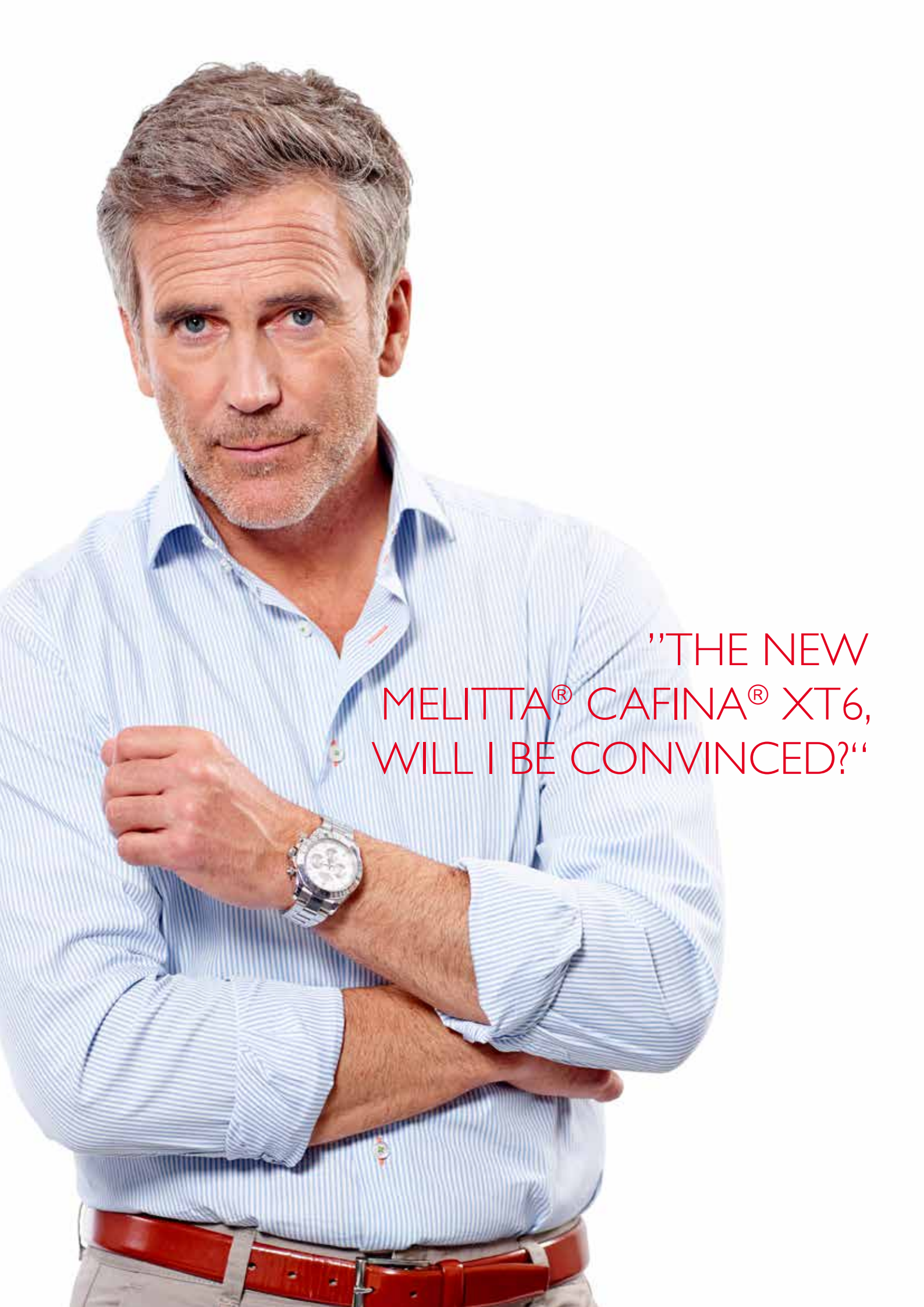

"THE NEW  
MELITTA® CAFINA® XT6,  
WILL I BE CONVINCED?"



# NOW VARIETY COMES WITH EVERY CUP.

Espresso, espresso macchiato, latte macchiato, cappuccino, tea or cocoa – with the Cafina® XT6 you can prepare a wide variety of specialities, with outstanding quality every time. Your guests will need to come back a few times before they have tried them all. And they are sure to be impressed every time.

"I FIND THE VARIETY TOTALLY CONVINCING  
AND I'M SURE MY GUESTS WILL AS WELL."

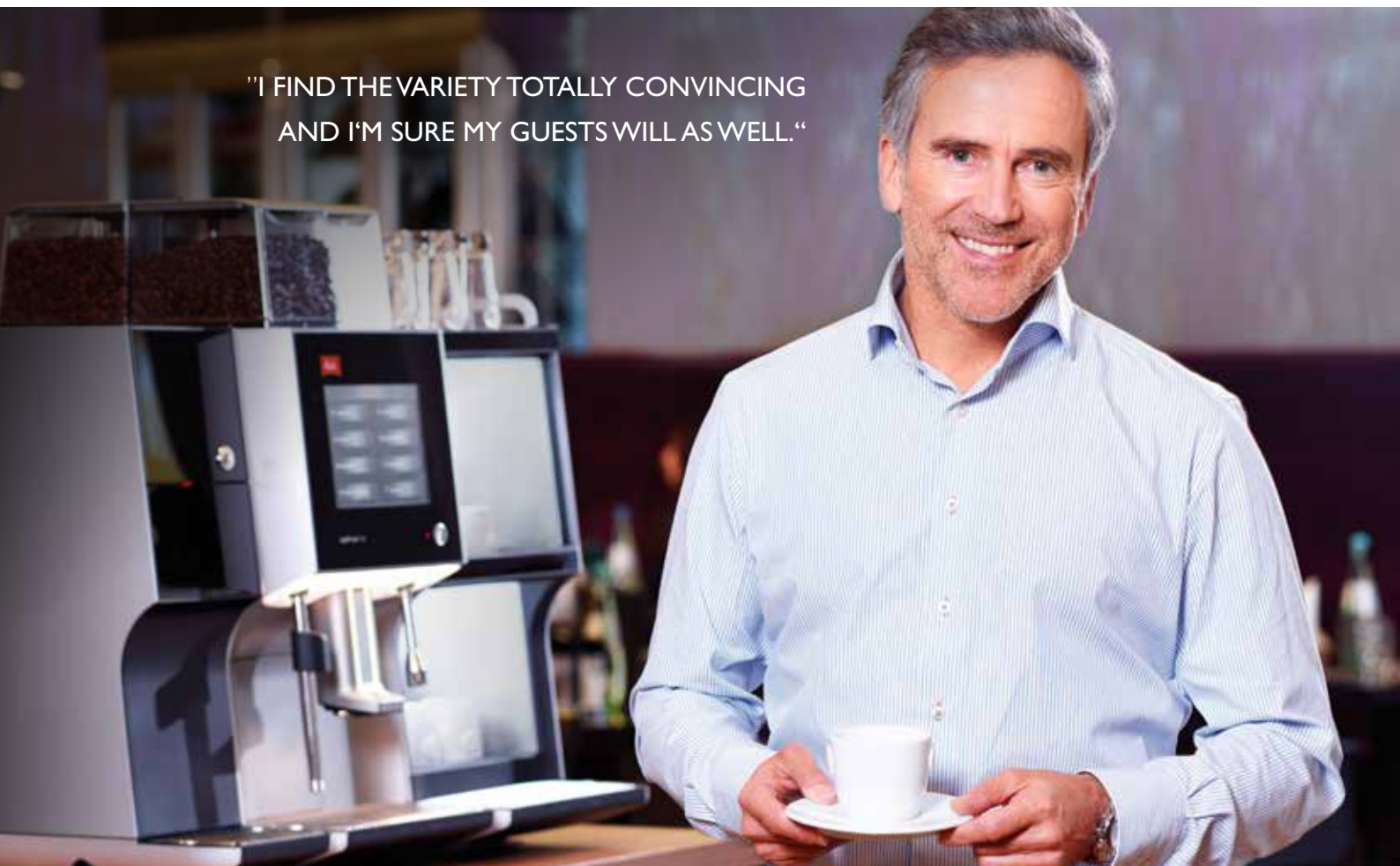



The selection is convincing and the quality is inspiring



### COFFEE BEAN AND INSTANT CONTAINERS

In addition to the two coffee bean containers, each with a capacity of 1 kg, the Cafina® XT6 also has two instant containers, each holding 450-800 grams of powder. The drink is prepared in the mixer unit. Any remaining powder is sucked out, keeping the pipes clear.

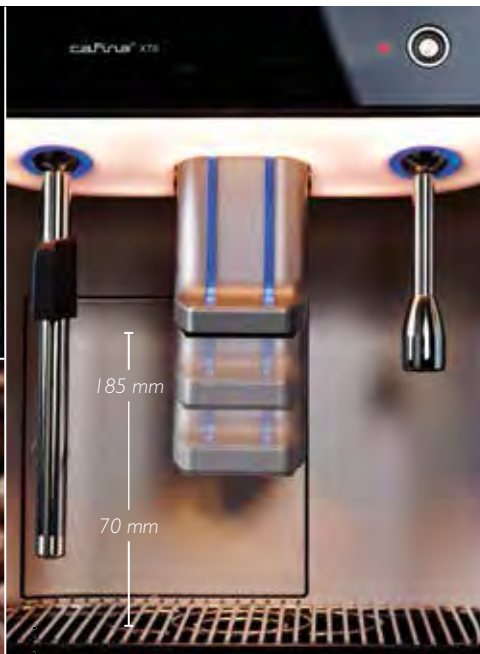

### ADJUSTABLE TO SUIT EVERY SPECIALITY

Your perfectly prepared speciality is ready for you to take from the accentuated and lit dispenser, which is conveniently and infinitely height-adjustable from 70 to 185 mm, suitable for any height of cup or glass.



### HOT OR COLD MILK FOAM

The brand new milk foam system gives you the choice between a hot milk or a cold milk foam, as well as cold and warm milk, individually programmable, for every coffee speciality in up to four variants. The foam is produced quickly and consistently and the even foam guarantees a heavenly feel in the mouth.

# A DESIGN ICON PROVIDES THE SETTING FOR YOUR COFFEE SPECIALITIES.

Clear lines, silver accents, black and white – the Cafina® XT6 has a contemporary look to show off its up-to-date technology. Added to this is the high quality of the carefully selected materials, such as the 3 mm thick aluminium side panels and the robust industrial-quality touchscreen display, which reacts immediately to any touch.



*Fits in perfectly with any room design*



*LED on: Specialities enhanced to perfection*

## SPACE-SAVING

With its compact dimensions – 300 mm wide, 580 mm high, 715 mm deep – and elegant aluminium housing, the Cafina® XT6 fits in well at any location. The extension modules follow the same design and form a functional and structural unit together with the XT6.



W × D × H: 300 × 580 × 715 mm



W × D × H: 180 × 580 × 580 mm



W × D × H: 300 × 580 × 580 mm



W × D × H: 300 × 580 × 580 mm

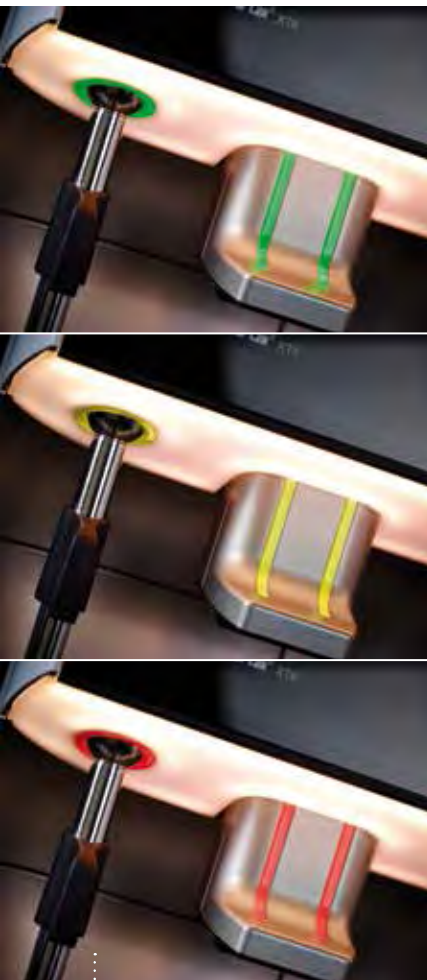

"THE CAFINA® XT6 LOOKS TRULY GREAT AND YOUR GUESTS ARE SURE TO BE IMPRESSED."

### YOUR SELECTION ENHANCED TO PERFECTION

The Cafina® XT6 is accentuated further thanks to its atmospheric lighting. The products are presented in an even better light: The entire cup area is lit by daylight LEDs to enhance cups and glasses together with their contents in a bright and natural way.



reddot award 2014  
winner

# YOU CAN ONLY GET PREMIUM QUALITY OUT IF THERE IS PREMIUM QUALITY ON THE INSIDE

The Cafina® XT6 could not have been developed without Melitta's many customers in the catering industry. Their requirements and suggestions were taken into account and found their way into the specifications of a new generation of automatic coffee machines. In-depth market analysis was also carried out to establish the requirements of guests. Then a wide variety of innovative developments were required in order to launch a model that would lead the way in its class when it comes to technology and operation.



## HARD-WEARING TOUCH-SCREEN DISPLAY

A light touch on the coloured, hard-wearing TFT touchscreen display is all it takes. The set quantity of coffee beans are ground.

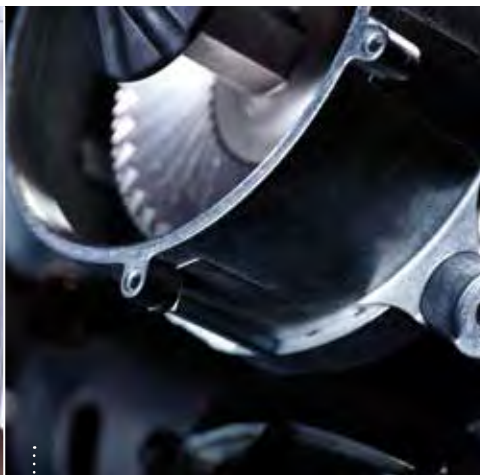

## LONG-LASTING GRINDER

The grinding process takes place in a specially developed grinder made from tool steel with wide diameter (75 mm) grinding disks. This represents a further development of the industry standard made by Melitta. The grinding disks are extremely hard-wearing - lasting for approx. 100,000 uses. The grinder works particularly fast, producing even and fine grounds.



## NO READJUSTMENTS REQUIRED

ACS® automatically readjusts the grinding disks throughout their entire lifetime. It adjusts the coarseness of grounds, quantity of powder, pressure, brewing time and water temperature. The quality remains high, the amount of coffee required is low and no service appointments are required for readjustment.





### STAINLESS STEEL BREWING UNIT

The ground coffee (up to 20 g) drops into the brewing unit. Variable pressure (VPS®) is used for each coffee speciality. The brewing unit is also made from stainless steel. Compared with plastic, this enables the use of higher pressure and a longer service life with consistently high quality.



### FINE SIEVE FOR FULL FLAVOUR

The micro-fine sieve enables the use of the finest grade of coffee grounds, without any grounds going into the cup. The sieve has more than 45,000 holes for a diameter of around four centimetres. The particularly finely ground coffee releases an unbelievably full aroma, even with small quantities.



### NEW MILK FOAM SYSTEM

Now all you need is the perfect foam. Our brand new milk foam system makes it easy to serve a cappuccino with a hot milk or a cold milk foam in an instant.

"THE MELITTA® CAFINA® XT6 SETS NEW TECHNICAL STANDARDS. NOW I UNDERSTAND WHY THE QUALITY IN THE CUP IS SO HIGH – IT'S SURE TO HELP ME GAIN SOME NEW CUSTOMERS!"



# READY FOR THE RUSH: IN SELF-SERVICE OR SERVICE STAFF MODE

Company canteens and hotel breakfast buffets are the ideal place for the Cafina® XT6.

Both of these are used to a rush of guests all at the same time. This is where the self-service Cafina® XT6 really comes into its own thanks to its reliability, rapid service and clear operation concept. Are there enough cups and glasses? Are the containers full?

These are the only things you will need to concern yourself with.

In self-service mode, the touchscreen display offers up to ten specialities. You can select the language for the names of drinks on the top right. The price is also displayed and an icon is used to illustrate the size and shape of the drink container.

In service staff mode, each of up to ten buttons can be selected for an individual speciality or a product group. If a product group, for example "espresso products", is selected, the display shows all (up to ten) espresso specialities.

A large table has just placed an order? Use the batch function, a memory function of the Cafina® XT6. Select the drinks you require and type "batch order". All the orders are listed in the batch window and can then be retrieved one after the other.

Another request comes in the meantime? No problem. Enter the drink and then continue to work on the order in the batch window.

The module system is also ideal, especially when it comes to training new staff.

You can have a latte macchiato in the medium size but what about a ristretto?

Just select "Modules" and then the size M and the product group coffee. All the coffee specialities that are available in size M will then be shown, including ristretto.



*The ergonomically tilted touchscreen display is easy to read even in bright light.*



*Each display button can be used to display a full group of products*



*An order from an entire table: Just enter once in „batch mode“*



# FULLY AUTOMATIC CLEANING WITH COMBI TABLET

What about cleaning? This is either set according to a time schedule – generally once a day – or the machine displays when it needs to be cleaned.

Daily cleaning takes place automatically using the CIP® (Clean in Place) cleaning system. Nothing needs to be dismantled for this cleaning to take place. After starting the cleaning program, the milk pipe and milk foamer are cleaned with the aid of cleaning tablets and then rinsed completely automatically.



CIP® is the only cleaning system of this kind to have received the HACCP certification for strict standards of hygiene.

"OPERATION: SIMPLY  
GREAT. AND IT IS REALLY  
QUICK TO CLEAN."



Fully automatic cleaning with combi tablets



"NOTHING BUT PRAISE FROM OUR GUESTS"



"MY MACHINE, SET JUST HOW I WANT IT"



"MY CAFINA® XT6 NEVER MESSES ME AROUND"

## QUALITY THAT PAYS FOR ITSELF, CUP AFTER CUP.

The Melitta® Cafina® XT6 will set the standard for automatic coffee machines over years to come. In its design phase, the objective of a dual quality promise was therefore put into practice:

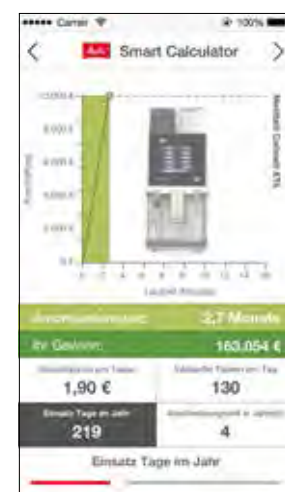

Our service for you: Our Melitta field sales staff will be happy to come and show you how quickly the Cafina® XT6 will pay for itself. They can give you a simple and precise forecast to fit in with your figures.



"I'VE BEEN OVER IT WITH A FINE TOOTHCOMB: IT REALLY DOES PAY FOR ITSELF"

The Cafina® XT6 provides the best quality for the guest, in the cup, and the best quality for the host as well. This is clear from the high level of reliability and low maintenance requirements.

Many different coffee specialities can be made easily and intuitively, with the same level of quality maintained over a long period, thanks to self-regulating technology.

The Cafina® XT6 can produce up to 170 cups of espresso per hour, thanks to its high heating performance of 2.6 kW. This is sufficient for use in hotels, restaurants, small to medium-sized cafés or bakeries and canteens. We will be happy to show you how cost-effective the Cafina® XT6 really is.

"QUALITY AND COST EFFICIENCY –  
EVERYTHING GOES TOGETHER!"



Use our Smart Calculator to work out how quickly the Melitta® Cafina® XT6 pays for itself.

**CALCULATE THE COST  
EFFICIENCY NOW**



## SERVICE YOU CAN RELY ON.

From the products to adjusting the quantities of ingredients, your Cafina® XT6 can be set up to suit your requirements. As far as quantities are concerned, we provide recommendations and then you can taste the products and tell us what you would like to change. We have tested our recommendations with Melitta coffee and it's best if you stick to these recommendations.

Although the Cafina® XT6 is built to require less maintenance than other automatic coffee machines, in particular thanks to the quality of the individual components, some maintenance work is still required. Descaling, replacing water filters or another wear and tear part or a current software version: All of this is taken care of by our own technical customer services. Our customer service technicians are available 365 days a year and are trained in all our models. Ensuring that coffee still tastes just as good as on the first day, even after many years.

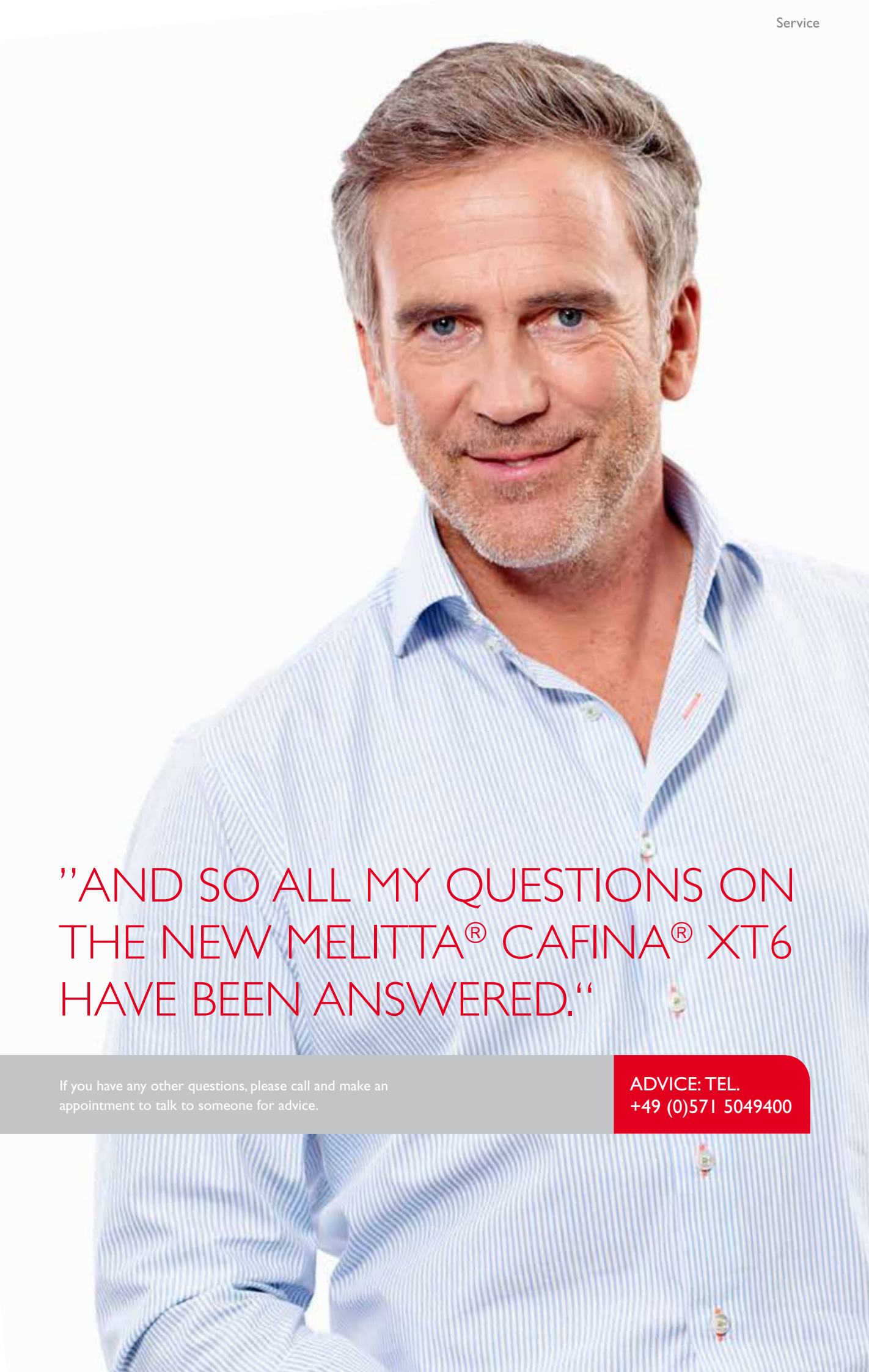

"AND SO ALL MY QUESTIONS ON  
THE NEW MELITTA® CAFINA® XT6  
HAVE BEEN ANSWERED."

If you have any other questions, please call and make an appointment to talk to someone for advice.

ADVICE: TEL.  
+49 (0)571 5049400

**Melitta for the ultimate in coffee enjoyment®**



Melitta Professional Coffee Solutions GmbH & Co. KG • PO Box 13 26 • 32373 Minden/Germany  
Phone: +49 (0)571 5049-0 • Fax: +49 (0)571 5049-233 • E-Mail: [professional@melitta.de](mailto:professional@melitta.de) • [www.melitta-professional.de](http://www.melitta-professional.de)